

**VictorBilt<sup>®</sup>**

*Dealers Supply & Lumber Company, LLC*

*105 Airport Road, PO Box 5025, Greenville, SC 29606*

# Victorbilt Traditions Casement



**CASEMENT INSULATING GLASS WINDOWS - 24" GLASS**

UNIT DIM. 2' 6-1/2"  
RGH. OPG. 2' 4-1/8"

4' 10-1/8"  
4' 7-3/4"

7' 1-3/4"  
6' 11-3/8"

9' 5-3/8"  
9' 3"

8' 1-3/4"  
7' 11-3/8"

9' 1-3/4"  
8' 11-3/8"

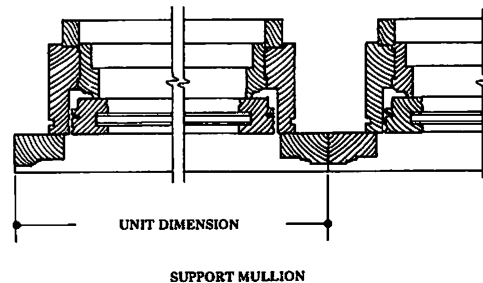
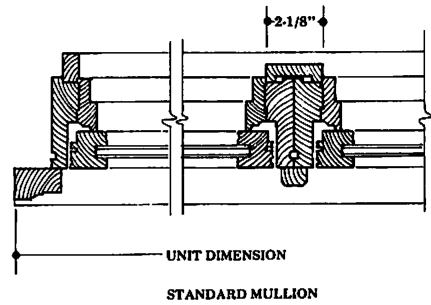
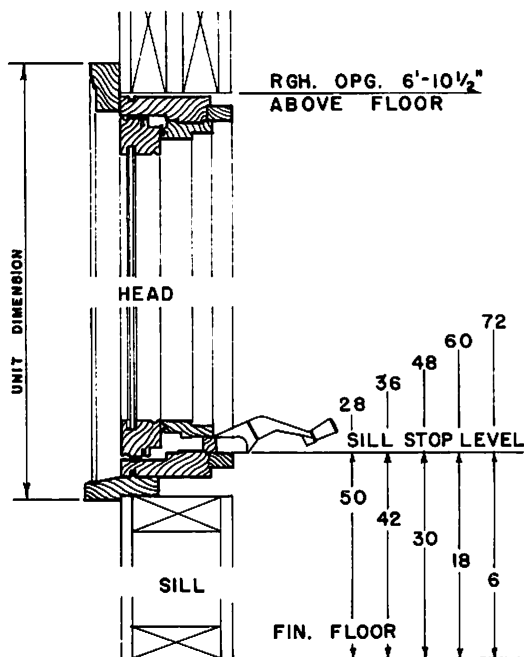
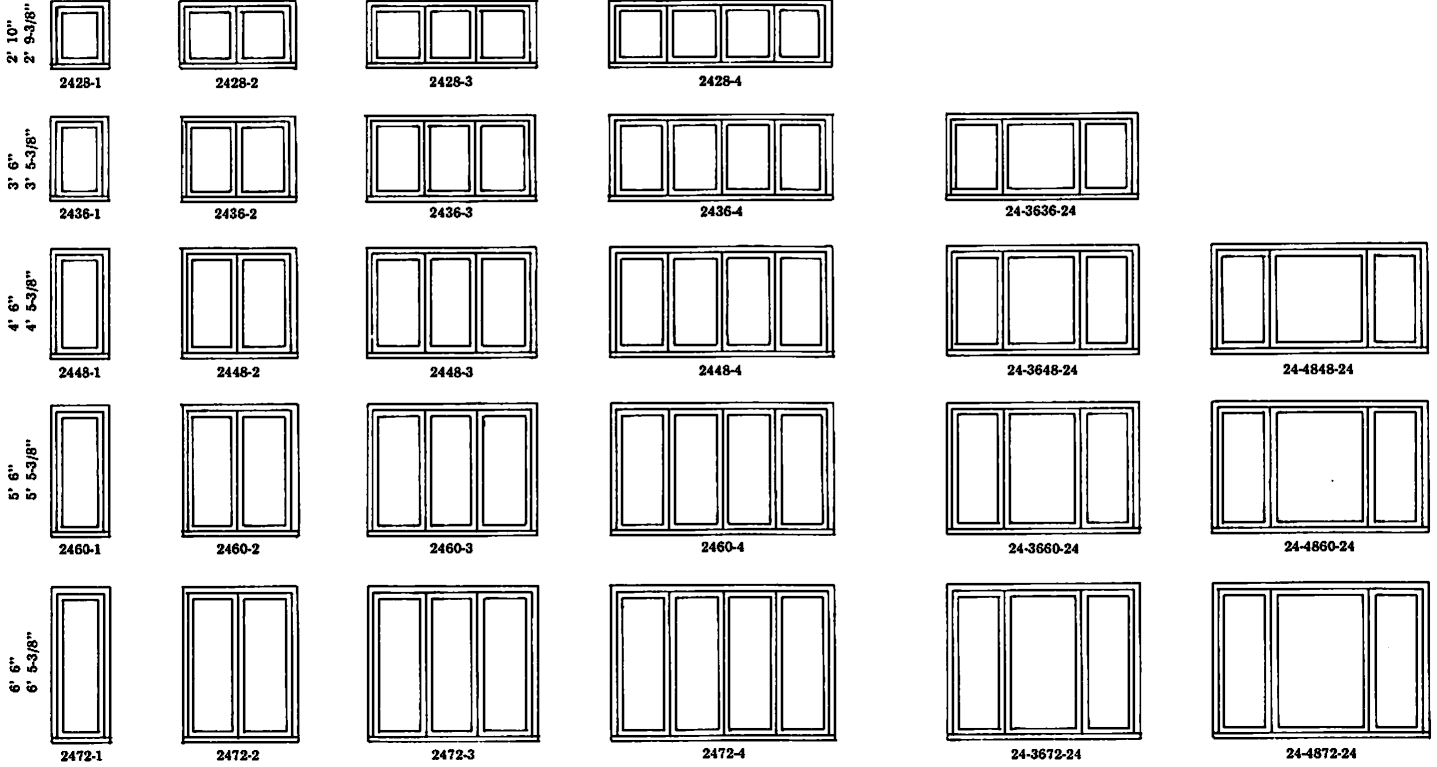

# VICTOR-BILT AWNING WINDOWS

## 2816 COMBINATIONS

UNIT DIM. 2' 10-1/2"  
RGH. OPG. 2' 8-1/8"

5' 6-1/8"  
5' 3-3/4"

8' 1-3/4"  
7' 11-3/8"

1' 10"  
1' 8-7/8"



2816-11

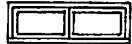

2816-21

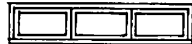

2816-31

3' 5-5/8"  
3' 4-1/2"



2816-12



2816-22



2816-32

5' 1-1/4"  
5' 0-1/8"

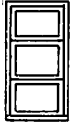

2816-13

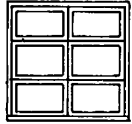

2816-23



2816-33

## 3616 COMBINATIONS

UNIT DIM. 3' 6-1/2"  
RGH. OPG. 3' 4-1/8"

6' 10-1/8"  
6' 7-3/4"

10' 1-3/4"  
9' 11-3/8"

1' 10"  
1' 8-7/8"



3616-11



3616-21



3616-31

3' 5-5/8"  
3' 4-1/2"



3616-12



3616-22



3616-32

5' 1-1/4"  
5' 0-1/8"

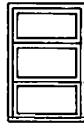

3616-13

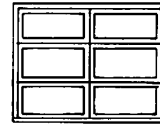

3616-23

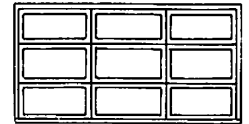

3616-33

## 2820 COMBINATIONS

UNIT DIM. 2' 10-1/2"  
RGH. OPG. 2' 8-1/8"

5' 6-1/8"  
5' 3-3/4"

8' 1-3/4"  
7' 11-3/8"

2' 2"  
2' 0-7/8"



2820-11



2820-21



2820-31

4' 1-5/8"  
4' 0-1/2"

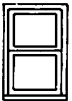

2820-12



2820-22

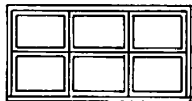

2820-32

6' 1-1/4"  
6' 0-1/8"

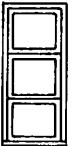

2820-13

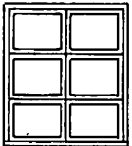

2820-23

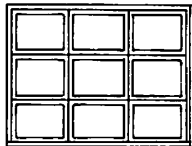

2820-33

## 3620 COMBINATIONS

UNIT DIM. 3' 6-1/2"  
RGH. OPG. 3' 4-1/8"

6' 10-1/8"  
6' 7-3/4"

10' 1-3/4"  
9' 11-3/8"

2' 2"  
2' 0-7/8"



3620-11



3620-21

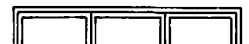

3620-31

4' 1-5/8"  
4' 0-1/2"

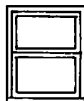

3620-12

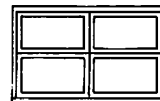

3620-22

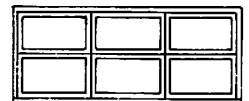

3620-32

6' 1-1/4"  
6' 0-1/8"

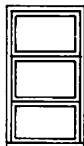

3620-13

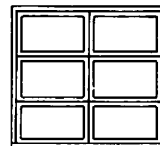

3620-23

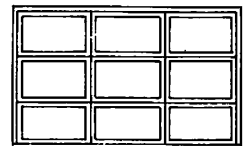

3620-33

## 2824 COMBINATIONS

UNIT DIM. 2' 10-1/2"  
RGH. OPG. 2' 8-1/8"

5' 6-1/8"  
5' 3-3/4"

8' 1-3/4"  
7' 11-3/8"

2' 6"  
2' 4-7/8"



2824-11



2824-21



2824-31

4' 9-5/8"  
4' 8-1/2"



2824-12

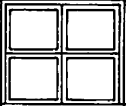

2824-22



2824-32

7' 1-1/4"  
7' 0-1/8"



2824-13

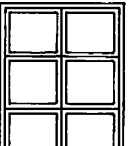

2824-23

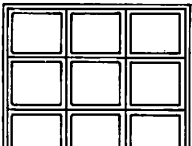

2824-33

## 3624 COMBINATIONS

UNIT DIM. 3' 6-1/2"  
RGH. OPG. 3' 4-1/8"

6' 10-1/8"  
6' 7-3/4"

10' 1-3/4"  
9' 11-3/8"

2' 6"  
2' 4-7/8"



3624-11

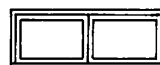

3624-21



3624-31

4' 9-5/8"  
4' 8-1/2"



3624-12



3624-22

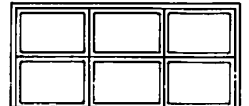

3624-32

7' 1-1/4"  
7' 0-1/8"

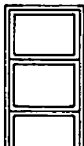

3624-13

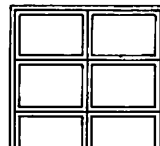

3624-23

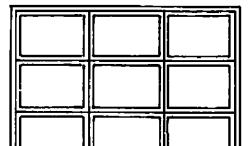

3624-33

### 4816 COMBINATIONS

UNIT DIM. 4' 6-1/2"      8' 10-1/8"      13' 1-3/4"  
 RGH. OPG. 4' 4-1/8"      8' 7-3/4"      12' 11-3/8"

1' 10" 1' 8-7/8"			
3' 5-5/8" 3' 4-1/2"			
5' 1-1/4" 5' 0-1/8"			

### 28" GLASS PICTURE COMBINATIONS

UNIT DIM. 2' 10-1/2"      5' 6-1/8"      8' 1-3/4"  
 RGH. OPG. 2' 8-1/8"      5' 3-3/4"      7' 11-3/8"

6' 1-5/8" 6' 0-1/2"			
6' 5-5/8" 6' 4-1/2"			
6' 9-5/8" 6' 8-1/2"			

### 4820 COMBINATIONS

UNIT DIM. 4' 6-1/2"      8' 10-1/8"      13' 1-3/4"  
 RGH. OPG. 4' 4-1/8"      8' 7-3/4"      12' 11-3/8"

2' 2" 2' 0-7/8"			
4' 1-5/8" 4' 0-1/2"			
6' 1-1/4" 6' 0-1/8"			

### 36" GLASS PICTURE COMBINATIONS

UNIT DIM. 3' 6-1/2"      6' 10-1/8"      10' 1-3/4"  
 RGH. OPG. 3' 4-1/8"      6' 7-3/4"      9' 11-3/8"

6' 1-5/8" 6' 0-1/2"			
6' 5-5/8" 6' 4-1/2"			
6' 9-5/8" 6' 8-1/2"			

### 4824 COMBINATIONS

UNIT DIM. 4' 6-1/2"      8' 10-1/8"      13' 1-3/4"  
 RGH. OPG. 4' 4-1/8"      8' 7-3/4"      12' 11-3/8"

2' 6" 2' 4-7/8"			
4' 9-5/8" 4' 8-1/2"			
7' 1-1/4" 7' 0-1/8"			

### 48" GLASS PICTURE COMBINATIONS

UNIT DIM. 4' 6-1/2"      8' 10-1/8"      13' 1-3/4"  
 RGH. OPG. 4' 4-1/8"      8' 7-3/4"      12' 11-3/8"

6' 1-5/8" 6' 0-1/2"			
6' 5-5/8" 6' 4-1/2"			
6' 9-5/8" 6' 8-1/2"			

# CASEMENT INSULATING GLASS WINDOWS

## CASEMENT INSULATING GLASS WINDOWS - 16" GLASS

UNIT DIM. 1' 10-1/2"  
RGH. OPG. 1' 8-1/8"

3' 6-1/8"  
3' 3-3/4"

5' 1-3/4"  
4' 11-3/8"

6' 9-3/8"  
6' 7"

6' 9-3/4"  
6' 7-3/8"

7' 9-3/4"  
7' 7-3/8"

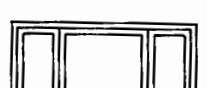
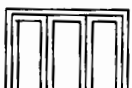
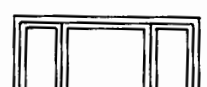
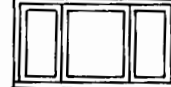
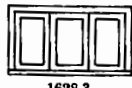

## CASEMENT INSULATING GLASS WINDOWS - 20" GLASS

UNIT DIM. 2' 2-1/2"  
RGH. OPG. 2' 0-1/8"

4' 2-1/8"  
3' 11-3/4"

6' 1-3/4"  
5' 11-3/8"

8' 1-3/8"  
7' 11"

7' 5-3/4"  
7' 3-3/8"

8' 5-3/4"  
8' 3-3/8"

